

Service Manual

Video

Grundig Service

Hotline Deutschland...
...Mo.-Fr. 8.00-16.30 Uhr

Technik:

TV/SAT	0180/52318-41
VCR/LiveCam	0180/52318-42
HiFi/Audio	0180/52318-43
Car Audio	0180/52318-44
Telekommunikation	0180/52318-45

Fax: 0180/52318-51

Ersatzteil-Bestellannahme:

Telefon:	0180/52318-40
Fax:	0180/52318-50

VHS

PAL / SECAM

HIGH SPEED
DRIVE

MEGALOGIC®

GV 740 HiFi
GV 740 NIC

Madrid /
SE 7106 HiFi
GV 7497 NIC

GV 660 HiFi
GV 660 NIC

GV 690 S HiFi
GV 690 S NIC



Zusätzlich erforderliche
Unterlagen für den Komplettservice

Additionally required
Service Manuals for the Complete Service

Ergänzung
Supplement

GV 740 ...
GV 7497 ...
SE 7106 HiFi
GV 67 ...
GV 69 ...

Sach-Nr./Part No.
72010-527.37

Service
Manual

Sicherheit
Safety

Sach-Nr./Part No.
72010-800.00

Service
Manual

GV 64 ...
GV 65 ...
GV 66 ...
SE 6106 HiFi

Sach-Nr./Part No.
72010-527.35

Ergänzung
Supplement

GV 67 ...
GV 69 ...

Sach-Nr./Part No.
72010-527.36

Service
Training

Sach-Nr./Part No.
© 72010-528.90
® 72010-528.91

Btx * 32700 #

Sachnummer
Part Number 72010-527.37

Änderungen vorbehalten
Subject to alteration

Printed in Germany
VK21/VK211 1097

Es gelten die Vorschriften und Sicherheitshinweise gemäß dem Service Manual "Sicherheit", Sach-Nummer 72010-800.00, sowie zusätzlich die eventuell abweichenden, landesspezifischen Vorschriften!



The regulations and safety instructions shall be valid as provided by the "Safety" Service Manual, part number 72010-800.00, as well as the respective national deviations.

D Inhaltsverzeichnis

	Seite
Allgemeiner Teil	1...4
Einführung	2
Geräteübersicht	3
 Platinenabbildungen & Schaltpläne	 5...18
Verdrahtungsplan	5
Bedieneinheit (QDCG1 / DC)	9
Buchsenplatte (QBG1 / CU)	13
Zusatz-Schaltplan für "Handshake"-Leitung der RS 232 Buchse	14
Chassisplatte (Layout 5)	14
Chassisplatte (Layout 4 und 5)	15
 Ersatzteillisten	 19...24

Einführung

In dieser Service-Manual-Ergänzung sind weitere Geräte der Serie GV 64 ..., GV 65 ..., GV 66 ..., SE 6106 HiFi dokumentiert. Nähere Informationen entnehmen Sie bitte der Geräteübersicht Seite 3. Zusätzlich sind die Änderungen der Geräte mit RS 232 Buchse (GV 660..., GV 690...) aufgeführt.

Bitte ergänzen Sie die Tabellen der Schaltpläne des Basis-Service-Manuals, Sach-Nr. 72010-527.35 wie nachfolgend beschrieben:

- In den Spalten GV 650 ... der Schaltpläne des Netzteils, der Chassisplatte und der IO-Platte sind die Gerätenamen GV 740 ... / GV 7497 NIC / SE 7106 HiFi hinzuzufügen.
- Bei der Empfangseinheit sind in der linken Spalte die Gerätenamen GV 740 HiFi / SE 7106 HiFi zu ergänzen und in der rechten Spalte GV 740 NIC / GV 7497 NIC.

Für die Geräteserie GV 660..., GV 690... kam zusätzlich eine Transistor-schaltung (Handshake) für die RS 232 Buchse hinzu. Beim Platinenlayout 4 ist die Beschaltung mit Drahtbrücken ausgeführt, bei Layout 5 ist diese in der Platine integriert.

Hinweis:

Grundlage für den Service sind folgende Service Manuals:

- Sicherheit, Sach-Nummer 72010-800.00
- Service Manual, Sach-Nummer 72010-527.35
- Ergänzung, Sach-Nummer 72010-527.36
- Service Training, Sach-Nummer 72010-528.90

Die Bausteinbestückung und die Sach-Nummern der einzelnen Bausteine entnehmen Sie bitte der Ersatzteilliste.

GB Table of Contents

	Page
General Section	1...4
Introduction	2
Video Recorder Overview	3
 Layout of the PCBs & Circuit Diagrams	 5...18
Wiring Diagram	5
Keyboard Control Unit (QDCG1 / DC)	9
Socket Board (QBG1 / CU)	13
Supplemental Circuit Diagram for Handshake Lead of the RS 232 Socket	14
Family Board (Layout 5)	14
Family Board (Layout 4 and 5)	15
 Spare Parts Lists	 19...24

Introduction

This Supplement Service Manual describes additional video recorders in the Series GV 64 ..., GV 65 ..., GV 66 ..., SE 6106 HiFi. For detailed information please see the Video Recorder Overview on page 3. The manual contains also the changes introduced in variants with RS 232 socket (GV 660..., GV 690...).

Please add the names of the following videorecorders to the tables of the circuit diagrams in the Main Service Manual, part number 72010-527.35:

- Enter additionally GV 740 ... / GV 7497 NIC / SE 7106 HiFi in column GV 650 ... on the circuit diagrams of the Power Supply, the Family Board and the IO-Board.
- Add the videorecorder names GV 740 HiFi / SE 7106 HiFi to the left column and the names GV 740 NIC / GV 7497 NIC to the right column for the Frontend.

Series GV 660..., GV 690... recorders are additionally fitted with a transistor stage (Handshake) for the RS 232 socket. The wiring of the circuit board Layout 4 is realised with wire bridges, the wiring of Layout 5 is integrated in the circuit board.

Note:

Basic instructions for servicing are given in the following Service Manuals:

- Safety, Part No. 72010-800.00
- Service Manual, Part No. 72010-527.35
- Supplement, Part No. 72010-527.36
- Service Training, Part No. 72010-528.91

For the individual modules and for the spare part numbers of the modules, please see the spare parts list.

Verdrahtungsplan / Wiring Diagram

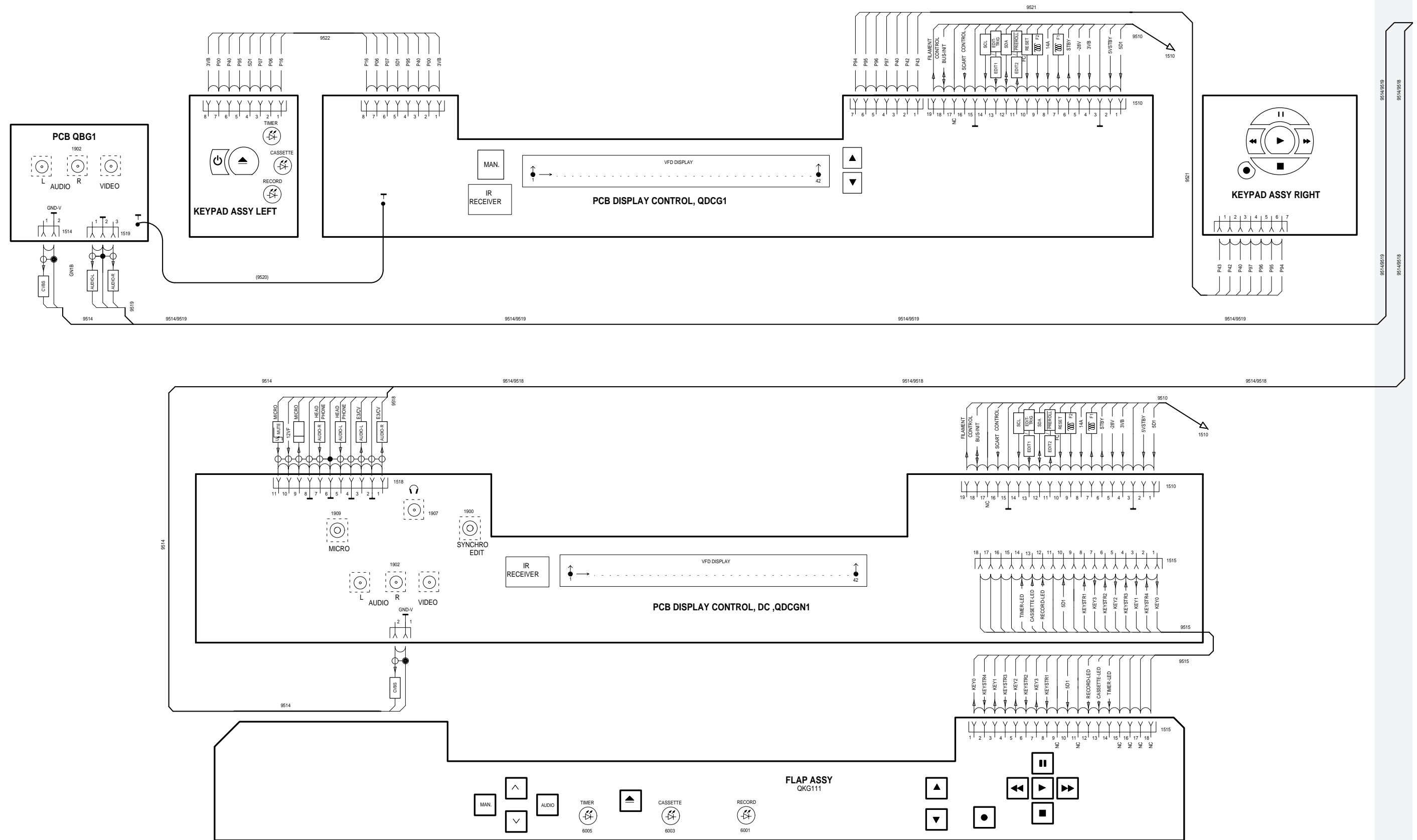

Reference	CF.....15	FE.....4-27	PS.....4-23	TM.....4-61
Oscillograms...	4-85, 27	CU.....4-70/77/84	HC.....4-59	SF.....21
AU.....4-36	DC.....4-67/75/82	IO.....4-33	SH.....17	VS.....4-55
CC.....4-47	DE.....4-51	OS.....4-62	SP.....not used	VT.....4-39

Seiten "4-..." - siehe Basis-Service-Manual / Pages "4-..." - see Main Service Manual

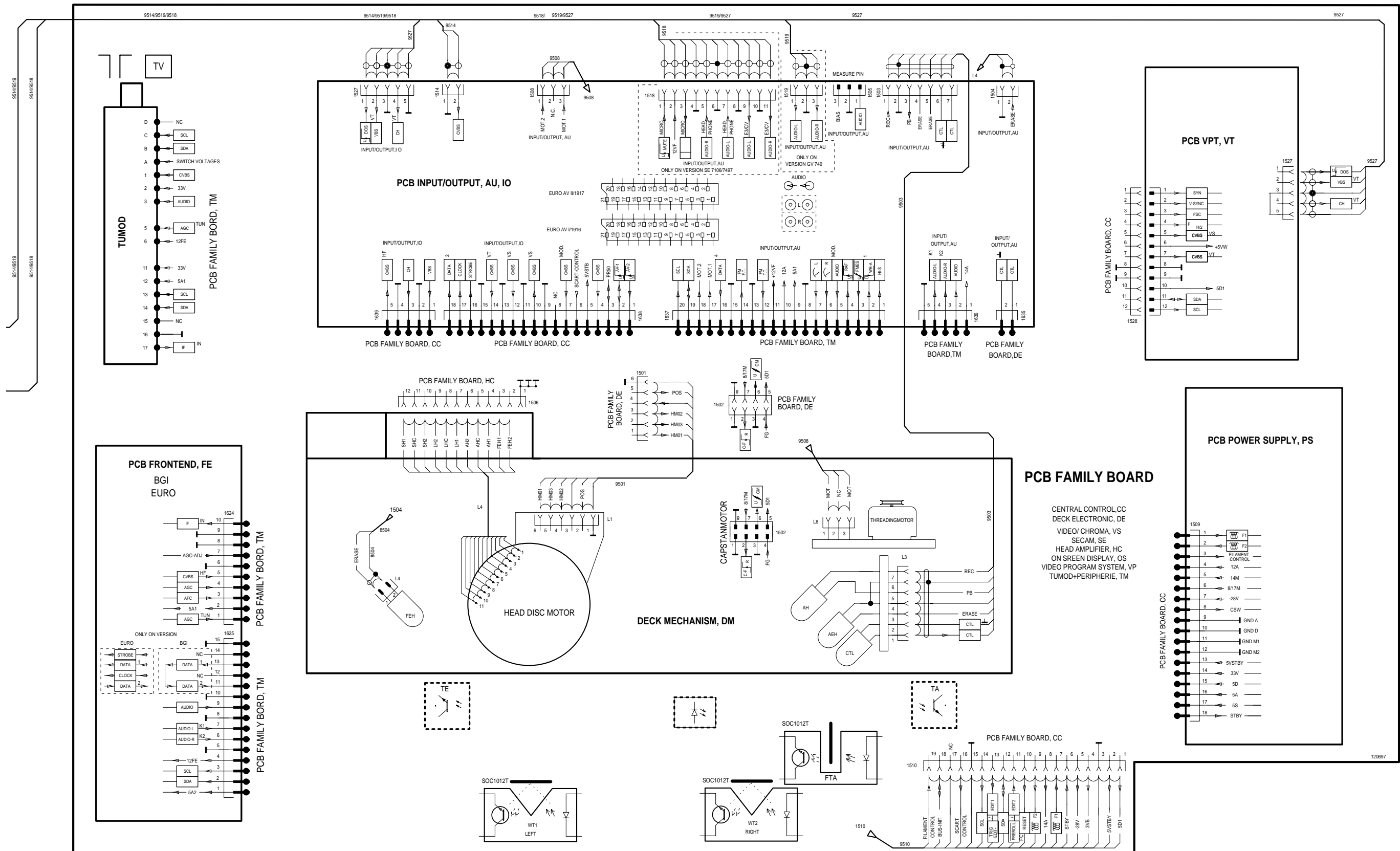

Bedieneinheit / Keyboard Control Unit (QDCG1 / DC)

Ansicht von der Bestückungsseite / View of Component Side

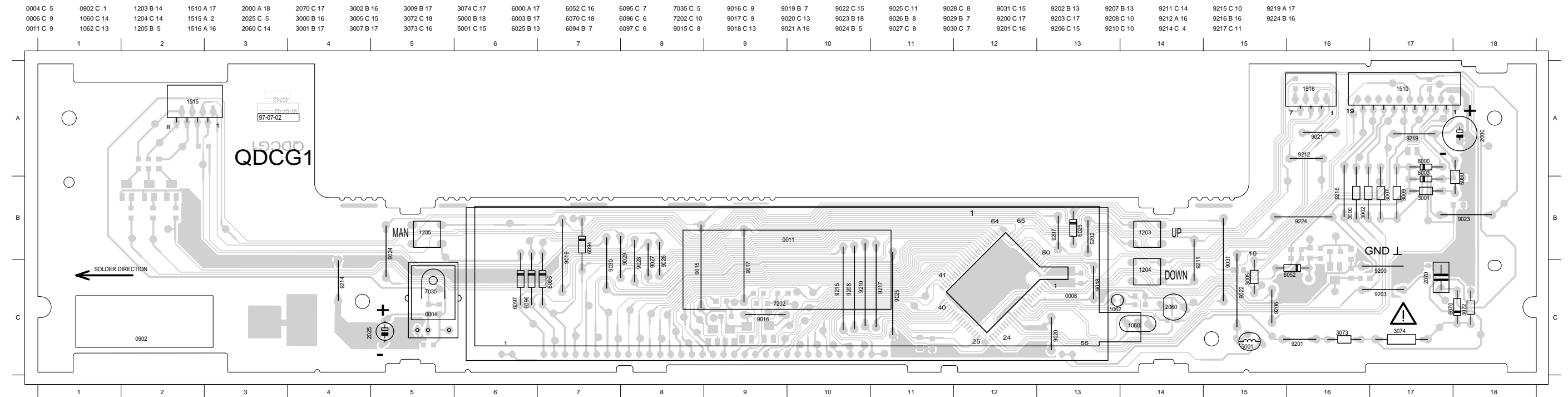

Ansicht von der Lötseite / View of Solder Side

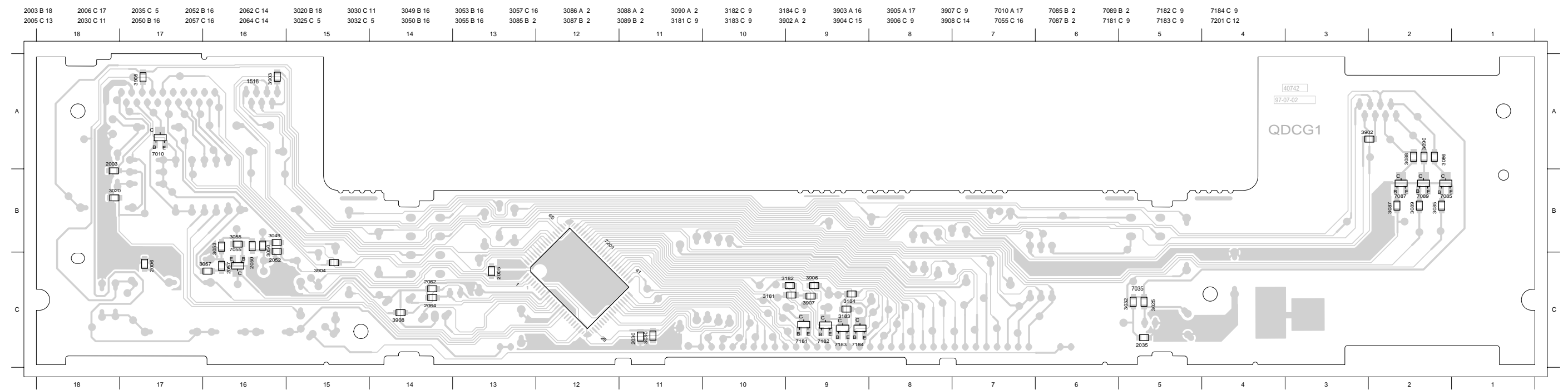

Bedieneinheit / Keyboard Control Unit (QDCG1 / DC)

Reference	CF	FE	PS	TM
Oscillograms...4-85, 27154-274-234-61
AU4-36	CU4-70/77/84	HC4-59	SF21	VP4-62
CC4-47	DC4-67/75/82	IO4-33	SH17	VS4-55
	DE4-51	OS4-62	SPnot used	VT4-39

Seiten "4-..." - siehe Basis-Service-Manual / Pages "4-..." - see Main Service Manual

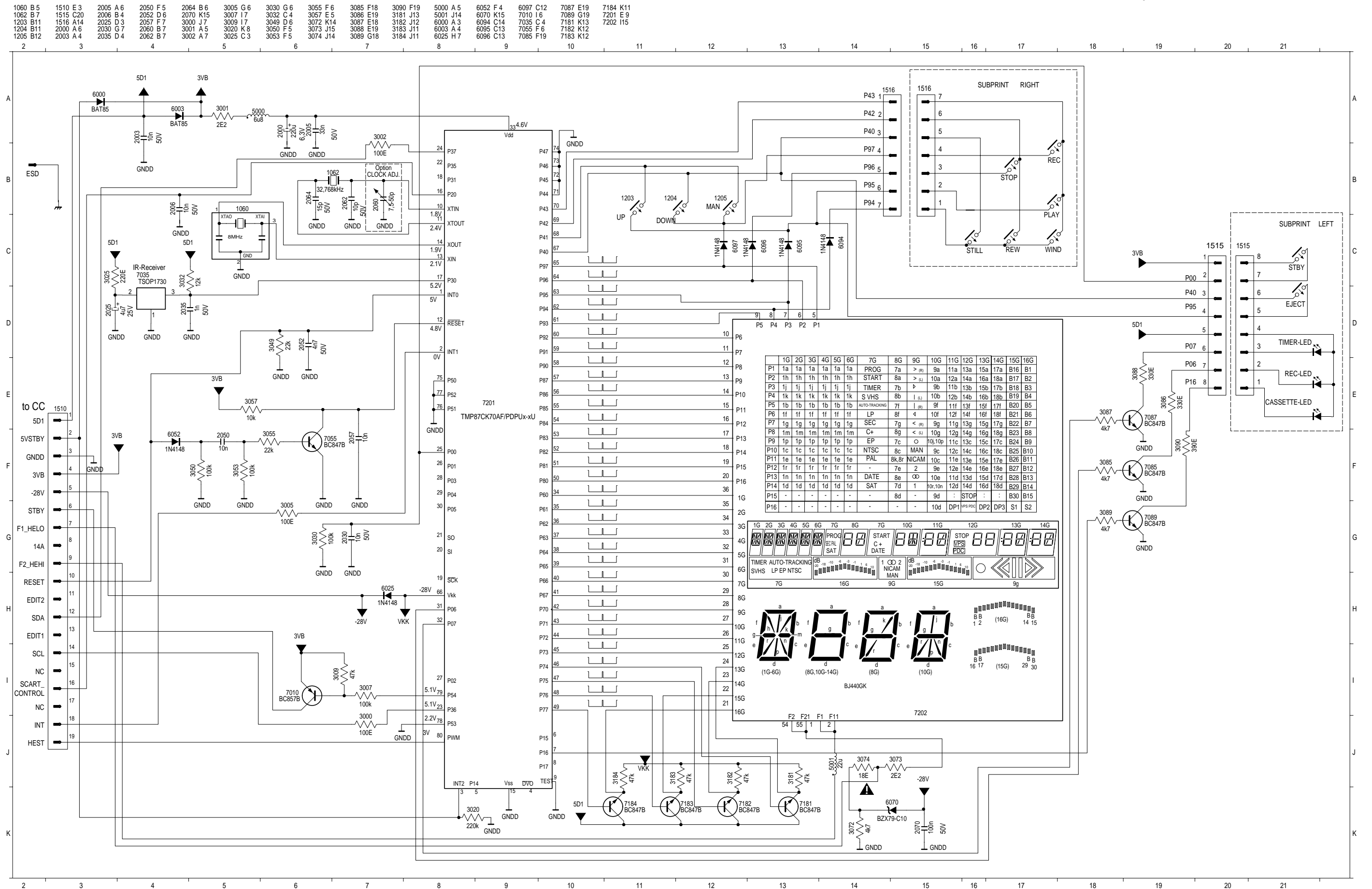

Buchsenplatte / Socket Board (QBG1)

Reference	CF.....15	FE.....4-27	PS.....4-23	TM.....4-61	
Oscillograms...	4-85, 27	CU.....4-70/77/84	HC.....4-59	SF.....21	VP.....4-62
AU.....4-36	DC.....4-67/75/82	IO.....4-33	SH.....17	VS.....4-55	
CC.....4-47	DE.....4-51	OS.....4-62	SP.....not used	VT.....4-39	

Seiten "4-..." - siehe Basis-Service-Manual / Pages "4-..." - see Main Service Manual

Ansicht von der Bestückungsseite / View of Component Side

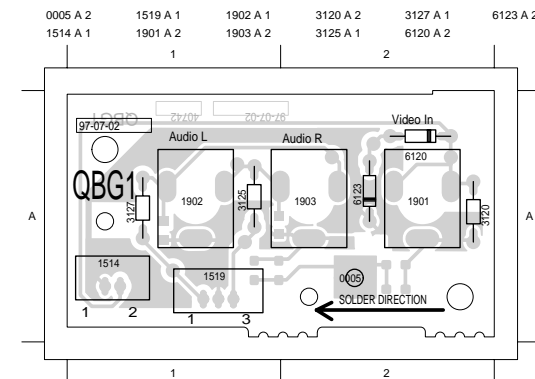

Ansicht von der Lötseite / View of Solder Side

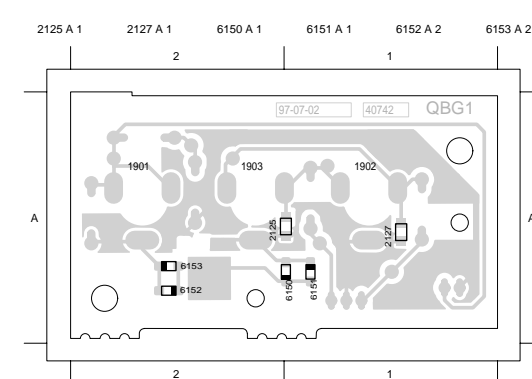

**Zusatz Schaltplan für "Handshake"-Leitung der RS 232 Buchse
Supplemental Circuit Diagram for Handshake Lead of the RS 232 Socket**

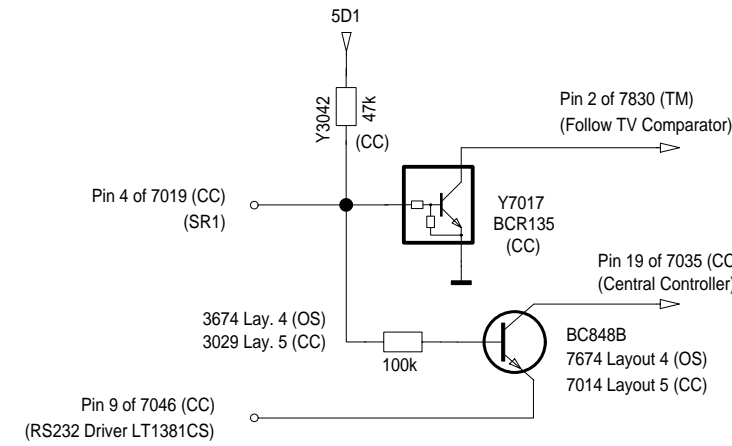

POS. NR. POS. NO.	SACHNUMMER PART NUMBER	BEZEICHNUNG DESCRIPTION
T 7017	75988-035.17	SMD-TRANS.BCR 135
T 7014	8301-004-848	SMD-TRANS.BC 858 B
T 7674	8301-004-848	SMD-TRANS.BC 858 B

Chassisplatte / Family Board (Layout 5)

**Ansicht von der Lötseite / View of Solder Side
(SMD Bestückung / SMD Assembly)**

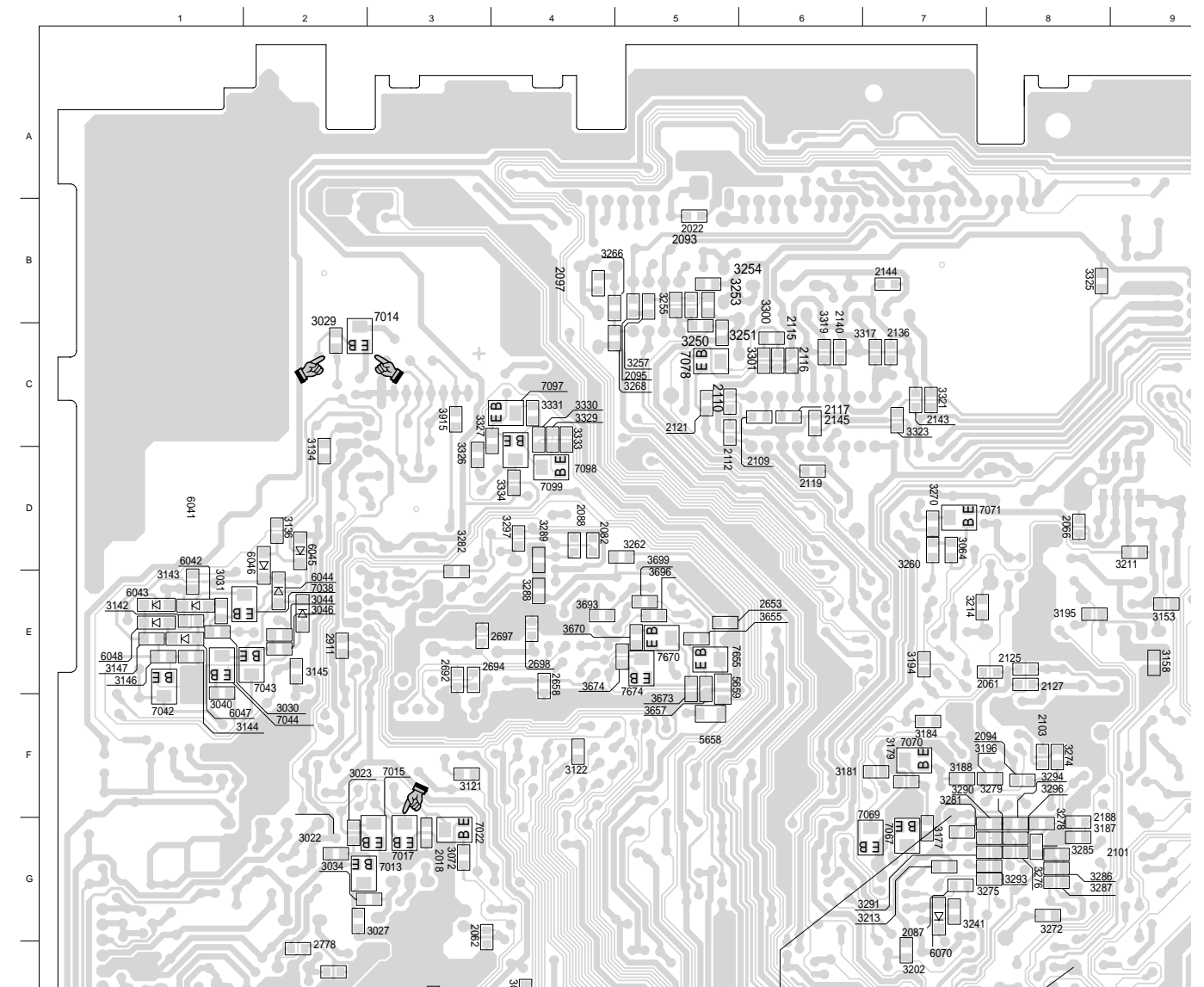

Chassisplatte / Family Board (Layout 5)

Ansicht von der Bestückungsseite / View of Component Side
(SMD Bestückung / SMD Assembly)

Nur bei Layout 4 / Only Layout 4

2013 14A	2046 17G	2128 14J	2182 5 G	2264 3 G	2564 4 C	2609 5 J	2639 7 J	2827 2 K	3012 17E	3049 15C	3082 16G	3140 14K	3167 11D	3197 10I	3222 9 D	3265 13J	3312 14I	3742 6 B	
2014 15A	2047 17G	2129 14J	2183 4 G	2268 2 F	2567 5 D	2610 5 J	2640 6 J	2829 2 K	3013 16D	3050 13C	3084 14E	3141 14K	3169 11D	3198 11D	3223 9 D	3271 10F	3313 14J	3743 6 B	
2016 17F	2050 10G	2131 14J	2189 11F	2282 3 E	2576 5 D	2613 6 J	2642 6 J	2832 3 J	3015 17F	3051 15B	3085 14E	3150 11D	3170 13E	3199 10E	3230 11D	3283 14I	3314 14J	3745 8 B	
2020 10A	2063 9 G	2150 4 H	2197 7 H	2316 3 E	2578 5 D	2614 5 K	2643 6 J	2842 3 K	3016 17F	3054 12D	3115 15B	3151 11D	3175 10F	3200 11D	3231 10E	3284 14I	3316 14J	3760 2 G	
2029 16E	2064 9 G	2152 4 H	2203 6 H	2327 3 F	2592 7 C	2615 6 I	2644 6 J	2844 3 K	3017 17F	3055 13C	3117 15D	3154 11D	3183 11F	3201 9 G	3236 10D	3292 14I	3318 14J	3761 14F	
2040 15I	2067 10D	2157 4 H	2205 7 G	2333 4 F	2601 6 J	2618 6 J	2645 7 I	2907 4 L	3035 17H	3057 12D	3118 14D	3155 9 G	3185 11F	3203 9 G	3240 11F	3295 14I	3320 14J	3765 2 H	
2041 15I	2068 10D	2159 5 H	2207 6 G	2344 5 F	2602 6 J	2620 6 I	2648 6 J	2910 4 L	3036 17H	3073 15B	3119 17G	3157 11E	3186 9 G	3205 9 G	3242 10G	3302 13J	3322 15I	3824 7 J	
2042 15I	2085 11F	2165 5 G	2236 3 H	2345 4 F	2603 6 J	2627 5 I	2649 7	3008 11B	3037 16F	3075 11B	3120 14D	3160 9 G	3190 12I	3206 9 G	3243 10G	3305 11I	3324 14J	3830 3 K	
2043 15I	2086 14I	2167 5 G	2245 4 G	2355 7 D	2605 5 J	2634 6 J	2659 13H	3009 11B	3042 14B	3077 11B	3125 13D	3163 9 F	3191 12I	3210 14J	3244 11F	3306 11I	3353 5 I	3832 3 K	
2044 15J	2091 10F	2169 4 H	2250 3 H	2356 7 D	2606 5 J	2635 7 K	2660 13I	3010 10B	3045 15A	3078 14B	3131 17G	3164 9 F	3192 11I	3219 9 D	3246 10G	3307 14I	3364 6 G	3834 3 K	
2045 17G	2106 12J	2181 6 G	2263 2 G	2363 4 C	2607 5 J	2638 8 I	2669 13H	3011 10B	3048 13C	3079 14B	3138 16I	3165 10D	3193 11I	3221 9 E	3261 9 I	3310 14I	3365 4 H	3836 3 K	
																		3367 4 G	3838 3 K
																		3369 4 G	3840 3 K
																		3373 7 G	3842 3 K
																		3382 4 G	3844 3 L
																		3384 7 F	3846 3 L
																		3385 5 G	3848 3 K
																		3394 7 H	3860 2 K
																		3397 7 H	3865 2 K
																		3399 7 H	3865 4 L
																		3407 6 G	3907 4 L
																		3417 7 H	3910 4 L
																		3418 6 H	3913 5 L
																		3427 4 H	5050 9 D
																		3434 3 J	5052 9 D
																		3437 3 H	5175 7 H
																		3440 4 G	5180 4 G
																		3460 3 E	5203 6 H
																		3482 3 C	5215 7 H
																		3490 3 C	5562 4 C
																		3491 3 C	5564 4 C
																		3493 3 D	5580 5 D
																		3510 3 F	5669 13G
																		3515 3 F	6000 13L
																		3516 3 E	6006 11L
																		3520 3 F	6049 17G
																		3525 6 F	6062 11G
																		3526 3 F	6095 11K
																		3528 4 E	6240 5 G
																		3534 3 F	6260 3 E
																		3536 4 G	6350 6 F
																		3537 4 G	6360 3 F
																		3538 4 F	6425 3 E
																		3544 6 F	6427 5 E
																		3545 6 F	6537 4 G
																		3546 7 G	6600 5 K
																		3547 5 J	6602 5 J
																		3548 6 F	6903 4 L
																		3552 8 E	7011 17E
																		3553 7 E	7016 17F
																		3557 6 D	7019 15B
																		3559 6 D	7023 10A
																		3560 4 B	7024 11A
																		3561 3 C	7025 11A
																		3567 5 C	7026 12E
																		3577 7 D	7032 17C
																		3578 7 D	7033 17C
																		3585 8 D	7035 15D
																		3586 8 C	7045 17H
																		3588 8 D	7046 15I
																		3589 7 C	7072 10H
																		3593 8 D	7074 11D
																		3595 7 C	7075 9 G
																		3596 7 C	7080 10D
																		3597 10H	7082 14I
																		3600 6 J	7083 14I
																		3601 5 K	7085 10F
																		3606 6 I	7091 14I
																		3607 6 I	7092 14I
																		3610 6 J	7165 5 H
																		3611 6 J	7170 7 G
																		3612 6 J	7185 6 G
																		3615 4 K	7195 7 H
																		3617 6 I	7200 7 H
																		3618 6 I	7217 7 H
																		3619 6 I	7225 4 H
																		3622 4 J	7235 3 H
																		3623 5 I	7250 3 H
																		3624 5 I	7305 3 C
																		3625 5 I	7320 3 G
																		3635 7 K	7340 5 F
																		3636 7 K	7360 4 D
																		3639 7 J	7380 7 F
																		3640 7 K	7552 8 D
																		3641 7 K	7560 4 C
																		3642 6 J	7588 8 C
																		3643 7 J	7596 7 C
																		3644 7 J	7600 5 J
																		3645 7 J	7620 7 J
																		3646 7 I	7635 7 K
																		3647 7 I	7640 7 J
																		3648 7 I	7645 7 K
																		3650 13I	7649 4 J
																		3660 13I	7650 13I
																		3662 13H	7664 13H
																		3664 13H	7690 14H
																		3665 13G	7720 7 B
																		3669 13H	7830 3 K
																		3705 7 B	7832 3 K
																		3710 7 B	7905 5 L

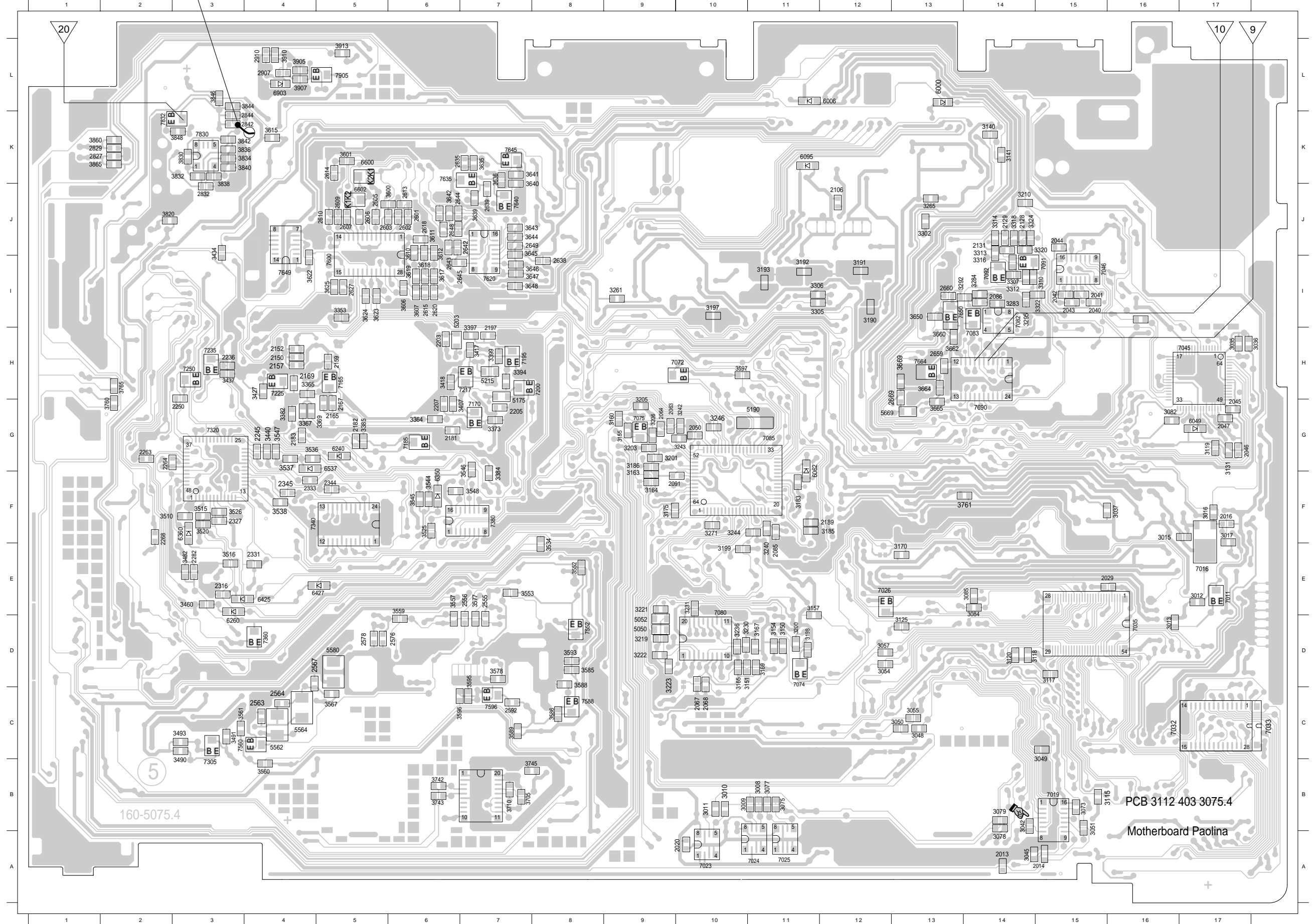

Chassisplatte / Family Board (Layout 4)

Ansicht von der Lötseite / View of Solder Side
(SMD Bestückung / SMD Assembly)

2012 3 J	2035 3 L	2082 4 D	2110 5 C	2143 7 C	2179 11 F	2260 14 F	2318 15 G	2347 12 H	2422 14 E	2575 13 I	2591 10 I	2622 13 D	2697 3 E	2825 16 D	3027 2 G	3072 3 G	3098 3 L	3527 12 H
2015 0 J	2037 3 L	2083 7 I	2112 5 C	2144 7 B	2185 12 F	2267 16 G	2321 15 G	2349 13 G	2550 10 H	2577 12 H	2593 10 I	2623 12 D	2698 4 E	2845 16 B	3029 2 C	3083 0 K	3099 3 K	3530 13 H
2017 3 H	2061 7 E	2087 7 G	2115 6 C	2145 6 C	2187 14 E	2269 16 H	2322 15 G	2350 13 H	2551 10 H	2579 12 H	2594 10 J	2626 13 D	2705 11 K	2900 13 A	3030 1 E	3086 5 I	3102 0 L	3531 13 H
2018 3 G	2062 3 G	2088 4 D	2116 6 C	2155 14 E	2271 16 H	2271 16 H	2325 14 H	2353 13 G	2554 11 I	2580 12 H	2595 10 J	2630 11 B	2715 10 K	2911 2 E	3031 1 E	3088 3 I	3109 3 I	3532 13 H
2021 8 L	2066 8 D	2093 5 B	2117 6 C	2156 14 E	2190 11 E	2273 16 H	2332 14 H	2355 12 E	2557 11 I	2581 12 H	2596 10 H	2637 11 C	2735 11 K	3001 7 L	3032 3 J	3089 3 K	3110 1 J	3533 12 H
2022 5 B	2071 9 I	2094 8 F	2119 6 D	2158 13 E	2215 11 E	2275 16 F	2338 13 H	2364 14 E	2558 12 I	2583 11 J	2597 10 G	2641 11 C	2749 10 K	3002 8 L	3034 2 G	3090 1 J	3111 0 J	3535 13 H
2023 3 H	2073 7 J	2095 4 B	2121 5 C	2163 13 F	2221 14 E	2285 15 D	2339 13 I	2367 15 D	2559 12 I	2585 11 I	2598 10 G	2646 14 C	2775 16 E	3005 7 L	3040 1 F	3091 1 J	3114 0 J	3536 13 G
2024 3 H	2077 8 I	2097 4 B	2125 8 E	2170 11 F	2235 15 F	2287 15 D	2340 13 G	2368 16 I	2560 12 I	2586 10 H	2611 13 D	2653 5 E	2776 2 H	3006 7 L	3044 2 E	3092 0 J	3114 0 J	3540 13 H
2027 2 K	2079 8 I	2101 8 G	2127 8 E	2175 11 F	2240 15 F	2292 15 H	2341 13 H	2369 16 I	2561 14 J	2587 10 H	2612 13 D	2658 4 E	2778 2 H	3007 2 G	3046 2 E	3094 1 J	3121 3 F	3542 12 G
2028 1 K	2080 7 I	2103 8 F	2136 7 C	2176 11 F	2243 14 G	2293 15 H	2343 13 H	2370 11 G	2562 14 J	2589 10 I	2616 12 D	2692 3 E	2785 16 C	3023 2 G	3064 7 D	3096 3 I	3122 4 F	3543 12 G
2030 2 I	2081 9 I	2109 5 C	2140 6 C	2178 12 F	2253 15 F	2295 15 J	2346 13 G	2380 11 G	2569 13 J	2590 10 I	2621 12 D	2694 3 E	2795 16 D	3024 4 H	3070 3 J	3097 1 J	3127 4 L	3549 12 G

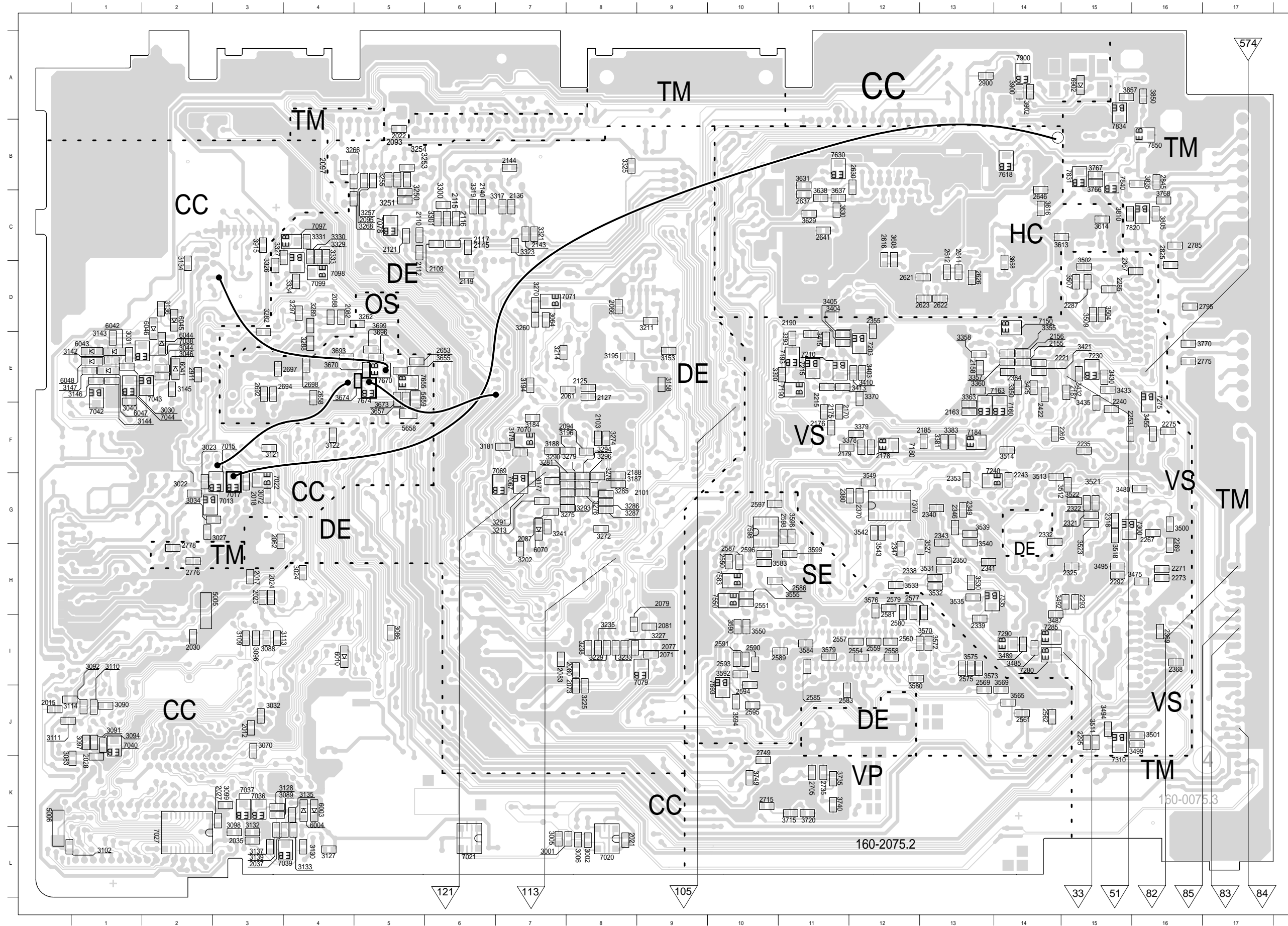

3098 3 L	3102 0 L	3109 3 I	3110 1 J	3111 0 J	3114 0 J	3121 3 F	3122 4 F	3127 4 L	3128 3 K	3130 4 L	3132 3 L	3133 3 L	3134 2 D	3135 3 K	3136 2 D	3137 3 L	3139 3 L	3142 1 E	3143 1 E	3144 1 E	3145 2 E	3146 1 E	3147 1 E	3153 9 E	3158 9 E	3177 7 G	3179 7 F	3181 6 F	3184 7 F	3187 9 G	3188 7 F	3194 7 E	3195 8 E	3196 7 F	3202 7 H	3211 9 D	3217 7 D	3214 7 F	3225 8 J	3227 8 I	3229 8 I	3233 8 I	3238 8 I	3239 8 I	3241 7 G	3250 5 C	3251 5 C	3253 5 B	3254 5 B	3255 5 B	3257 5 B	3260 7 D	3262 4 D	3266 4 B	3268 4 C	3270 7 D	3272 15 D	3274 8 F	3275 7 G	3276 8 G	3278 8 G	3279 7 G	3281 7 G	3282 3 E	3285 8 E	3286 8 G	3287 8 G	3288 4 E	3289 4 E	3291 7 G	3293 7 G	3294 8 G	3296 8 G	3297 4 D	3300 6 G	3301 6 C	3317 6 C	3319 6 C	3321 7 C	3323 7 C	3325 8 B	3326 8 B	3327 3 C	3329 4 C	3330 4 C	3331 4 C	3333 4 C	3334 4 D	3350 14 E	3355 14 E	3357 14 E	3358 13 E	3360 13 E	3363 13 F	3370 11 E	3378 11 F	3379 11 F	3381 13 F	3383 13 F	3390 10 E	3393 11 E	3403 12 E	3404 11 E	3405 11 E	3410 11 E	3413 11 E	3415 11 E	3421 14 E	3425 14 E	3430 15 E	3432 15 E	3433 15 E	3435 15 F	3455 15 J	3475 15 H	3480 15 G	3485 14 I	3487 14 I	3489 14 I	3492 14 H	3494 15 J	3495 15 H	3499 15 J	3500 16 G	3501 15 J	3502 15 D	3504 15 D	3507 15 D	3509 15 D	3511 15 J	3512 14 G	3513 14 G	3514 14 F	3518 15 G	3521 15 G	3522 15 G	3523 15 G	7900 14 A
----------	----------	----------	----------	----------	----------	----------	----------	----------	----------	----------	----------	----------	----------	----------	----------	----------	----------	----------	----------	----------	----------	----------	----------	----------	----------	----------	----------	----------	----------	----------	----------	----------	----------	----------	----------	----------	----------	----------	----------	----------	----------	----------	----------	----------	----------	----------	----------	----------	----------	----------	----------	----------	----------	----------	----------	----------	-----------	----------	----------	----------	----------	----------	----------	----------	----------	----------	----------	----------	----------	----------	----------	----------	----------	----------	----------	----------	----------	----------	----------	----------	----------	----------	----------	----------	----------	----------	----------	----------	-----------	-----------	-----------	-----------	-----------	-----------	-----------	-----------	-----------	-----------	-----------	-----------	-----------	-----------	-----------	-----------	-----------	-----------	-----------	-----------	-----------	-----------	-----------	-----------	-----------	-----------	-----------	-----------	-----------	-----------	-----------	-----------	-----------	-----------	-----------	-----------	-----------	-----------	-----------	-----------	-----------	-----------	-----------	-----------	-----------	-----------	-----------	-----------	-----------	-----------

3

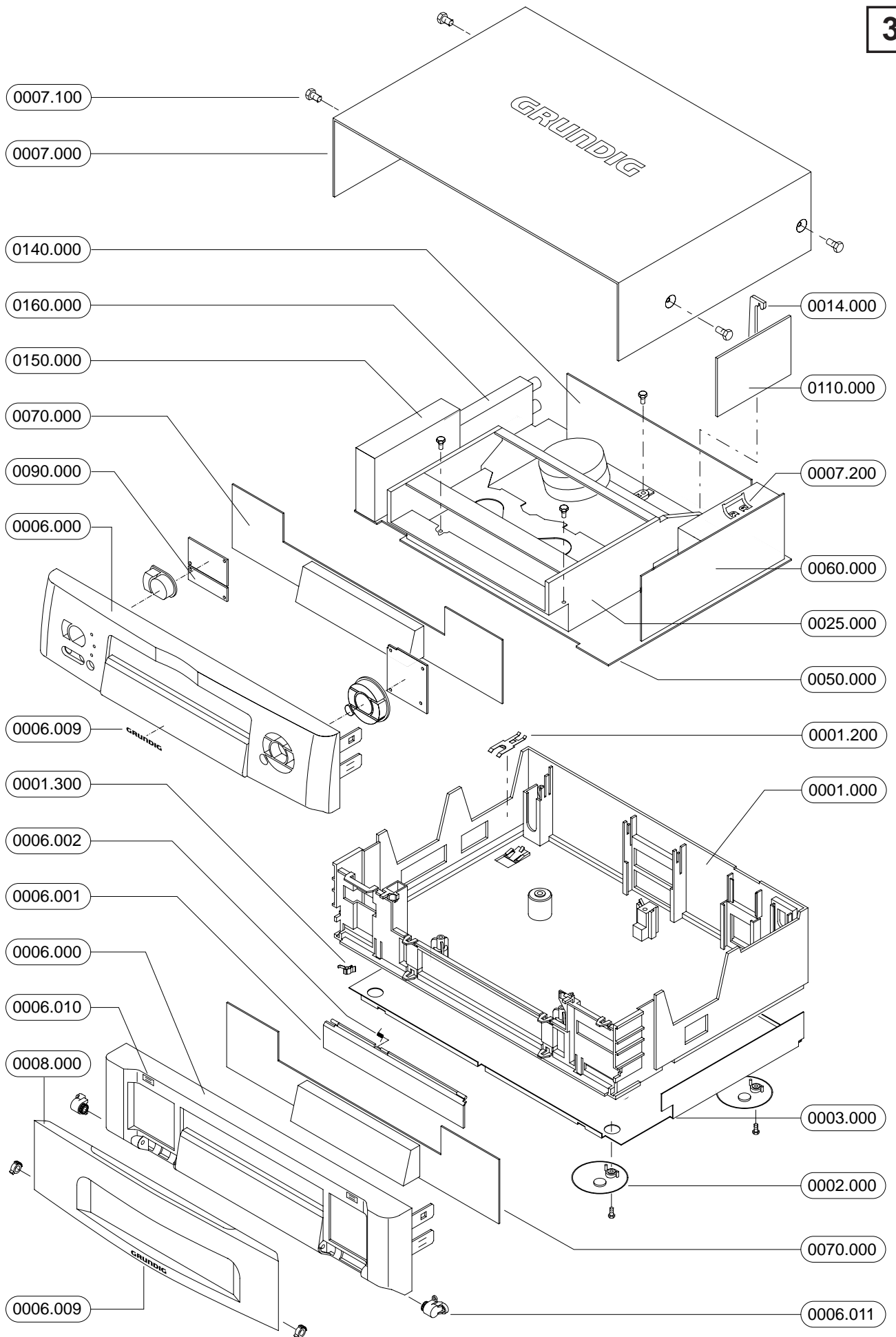

Ersatzteilliste
Spare Parts List

09 / 97

GRUNDIG

VIDEO

GV 740 HIFI

SACH-NR. / PART NO.: 77400-834.51
BESTELL-NR. / ORDER NO.: G.MG 3000

POS. NR. POS. NO.	ABB. FIG.	SACHNUMMER PART NUMBER	ANZ. QTY.	BEZEICHNUNG (D)	DESCRIPTION (GB)
0001.000	3	75988-035.27		RAHMEN	FRAME
0001.200	3	27034-208.00	2	MASSEFEDER	EARTH SPRING
0001.300	3	75988-028.62		KONTAKTFEDER	CONTACT SPRING
0002.000	3	75988-000.02	2	FUSS	FOOT
0003.000	3	75988-036.00		BODEN	BOTTOM
0006.000	3	75988-041.07		FRONTPLATTE KPL.	FRONT PANEL CPL.
0006.001	3	75988-041.09		CASSETTENFACHKLAPPE	LIFT FLAP
0006.002	3	75988-000.08		SCHENKELFEDER	LEG SPRING
0006.009	3	75988-324.04		SCHRIFTZUG	LABEL
0007.000	3	75988-036.04		DECKEL	LID
0007.100	3	75988-037.36	4	SCHRAUBE 3,5X10	SCREW 3,5X10
0007.200	3	75988-037.64		MASSEFEDER	EARTH SPRING
0013.000	3	75988-018.18		SCHRAUBE, AUDIO SUPPORT	SCREW, AUDIO SUPPORT
0014.000	3	75988-039.51		PLATINENHALTER	HOLDER PLATINE
0015.000	Δ	75988-009.52		NETZKABEL	POWER CABLE
0021.000		75988-010.75		FERNBEDIENUNG RP 500	REMOTE CONTROL RP 500
0021.100		72011-650.00		FERNBEDIENUNG RP 7	REMOTE CONTROL RP 7
0023.000		75988-036.05		EURO-AV KABEL 13 POL.	EURO-AV CABLE 13P
0025.000	Δ 3	75988-025.50	X	LAUFWERK KEIN E-TEIL	DRIVE MECHANISM NO SPARE PART
0026.000		75988-037.19	2	DISTANZHALTER DECK	SPACER DECK
0033.000	1	27599-005.24		KOPFRAD 4/2	HEAD WHEEL 4/2
0034.000	1	75988-023.10		SCANNERMOTOR 4/2	SCANNERMOTOR 4/2
0050.000	Δ 3	27599-001.93	X	LP-CHASSIS A.PMB8 KEIN E-TEIL	PCB-CHASSIS A.PMB8 NO SPARE PART
0060.000	Δ 3	27599-003.20	X	NETZTEILPLATTE PSM2B KEIN E-TEIL / G	POWER SUPPLY BOARD PSM2B NO SPARE PART / G
0070.000	Δ 3	27599-002.75	X	BEDIENPLATTE GDGC1 KEIN E-TEIL / G	CONTROL BOARD GDGC1 NO SPARE PART / G
0090.000	Δ 3	75988-041.10	X	BUCHSENPLATTE QBG1 KEIN E-TEIL / G	SOCKET BOARD QBG1 NO SPARE PART / G
0110.000	Δ 3	27599-009.03	X	VIDEOTEXT-PLATTE PVT2 KEIN E-TEIL / G	VIDEOTEXT BOARD PVT2 NO SPARE PART / G
0140.000	Δ 3	27599-009.51	X	IO/AUDIO PLATTE PIO9 KEIN E-TEIL / G	IO/AUDIO BOARD PIO9 NO SPARE PART / G
0150.000	Δ 3	75988-036.09	X	EMPFANGSEINHEIT A.PFE1-BG1 KEIN E-TEIL / G	FRONT END PANEL A.PFE1-BG1 NO SPARE PART / G
0160.000		75988-035.54		TUNER/MODULATOR PAL-BG	TUNER MODULATOR PAL-BG
8504.000		75988-035.56		LEITUNG SCR 2 POL.	CABLE SCR 2P
9501.000		75988-037.92		FLEXIBLE LEITUNG 6 POL.	FLEXIBLE CABLE 6P
9503.000		75988-035.58		FLEXIBLE LEITUNG SCR 7 POL.	FLEXIBLE CABLE SCR 7P
9508.000		75988-035.59		FLEXIBLE LEITUNG 3 POL.	FLEXIBLE CABLE 3P
9510.000		75988-036.03		FLEXIBLE LEITUNG 19 POL.	FLEXIBLE CABLE 19P
9514.000		75988-037.38		LEITUNG ABGESCHIRMT 2 POL.	CABLE SCREENED 2P
9519.000		75988-039.53		LEITUNG ABGESCHIRMT 3 POL.	CABLE SCREENED 3P
9521.000		75988-041.12		FLEXIBLE LEITUNG 7 POL.	FLEXIBLE CABLE 7P
9522.000		75988-041.13		FLEXIBLE LEITUNG 8 POL.	FLEXIBLE CABLE 8P
9527.000		75988-039.81		LEITUNG ABGESCHIRMT 5 POL.	CABLE SCREENED 5P
IC 7030		75988-041.11		EPROM QCVG6-1U	EPROM QCVG6-1U
		72010-530.85		BEDIENUNGSANLEITUNG D/GB/I	OPERATING INSTRUCTIONS D/GB/I
		72010-527.35		SERVICE MANUAL D/GB	SERVICE MANUAL D/GB
		72010-527.37		SERVICE MANUAL ERG. D/GB	SERVICE MANUAL SUPP. D/GB
		72010-528.90		SERVICE TRAINING D	SERVICE TRAINING D
		72010-528.91		SERVICE TRAINING GB	SERVICE TRAINING GB
				X = SIEHE GESONDERTE E-LISTE	X = SEE SEPARATE PARTS LIST

Btx *32700#

ÄNDERUNGEN VORBEHALTEN / SUBJECT TO ALTERATION

GRUNDIG

VIDEO

GV 740 NIC

SACH-NR. / PART NO.: 77400-835.51
BESTELL-NR. / ORDER NO.: G.MG 3100Ersatzteilliste
Spare Parts List

09 / 97

POS. NR. POS. NO.	ABB. FIG.	SACHNUMMER PART NUMBER	ANZ. QTY.	BEZEICHNUNG (D)	DESCRIPTION (GB)
0001.000	3	75988-035.27		RAHMEN	FRAME
0001.200	3	27034-208.00	2	MASSEFEDER	EARTH SPRING
0001.300	3	75988-028.62		KONTAKTFEDER	CONTACT SPRING
0002.000	3	75988-000.02	2	FUSS	FOOT
0003.000	3	75988-036.00		BODEN	BOTTOM
0006.000	3	75988-041.41		FRONTPLATTE KPL.	FRONT PANEL
0006.001	3	75988-041.42		CASSETTENFACHKLAPPE	LIFT FLAP
0006.002	3	75988-000.08		SCHENKELFEDER	LEG SPRING
0006.009	3	75988-324.04		SCHRIFTZUG	LABEL
0007.000	3	75988-036.04		DECKEL	LID
0007.100	3	75988-037.36	4	SCHRAUBE 3,5X10	SCREW 3,5X10
0007.200	3	75988-037.64		MASSEFEDER	EARTH SPRING
0013.000	3	75988-018.18		SCHRAUBE, AUDIO SUPPORT	SCREW, AUDIO SUPPORT
0014.000	3	75988-039.51		PLATINENHALTER	HOLDER PLATINE
0015.000	Δ	75988-009.52		NETZKABEL	POWER CABLE
0020.000		75988-009.53		HF-VERBINDUNGSKABEL	RF-CONNECTING CABLE
0021.000		75988-010.75		FERNBEDIENUNG RP 500	REMOTE CONTROL RP 500
0021.100		72011-650.00		FERNBEDIENUNG RP 7	REMOTE CONTROL RP 7
0023.000		75988-036.05		EURO-AV KABEL 13 POL.	EURO-AV CABLE 13P
0025.000	Δ 3	75988-025.50	X	LAUFWERK KEIN E-TEIL	DRIVE MECHANISM NO SPARE PART
0026.000	3	75988-037.19	2	DISTANZHALTER DECK	SPACER DECK
0033.000	1	27599-005.24		KOPFRAD 4/2	HEAD WHEEL 4/2
0034.000	1	75988-023.10		SCANNERMOTOR 4/2	SCANNERMOTOR 4/2
0050.000	Δ 3	27599-001.95	X	LP-CHASSIS A.PMB31 KEIN E-TEIL	PCB-CHASSIS A.PMB31 NO SPARE PART
0060.000	Δ 3	27599-003.20	X	NETZTEILPLATTE PSM2B KEIN E-TEIL / G	POWER SUPPLY BOARD PSM2B NO SPARE PART / G
0070.000	Δ 3	27599-002.75	X	BEDIENPLATTE GDGC1 KEIN E-TEIL / G	CONTROL BOARD GDGC1 NO SPARE PART / G
0090.000	Δ 3	75988-041.10	X	BUCHSENPLATTE QBG1 KEIN E-TEIL / G	SOCKET BOARD QBG1 NO SPARE PART / G
0110.000	Δ 3	27599-009.03	X	VIDEOTEXT-PLATTE PVT2 KEIN E-TEIL / G	VIDEOTEXT BOARD PVT2 NO SPARE PART / G
0140.000	Δ	27599-009.51	X	IO/AUDIO PLATTE PIO9 KEIN E-TEIL / G	IO/AUDIO BOARD PIO9 NO SPARE PART / G
0150.000	Δ 3	75988-036.15	X	EMPFANGSEINHEIT A.PFE2-BG1 KEIN E-TEIL / G	FRONT END PANEL A.PFE2-BG1 NO SPARE PART / G
0160.000		75988-035.54		TUNER/MODULATOR PAL-BG	TUNER MODULATOR PAL-BG
8504.000		75988-035.56		LEITUNG SCR 2 POL.	CABLE SCR 2P
9501.000		75988-037.92		FLEXIBLE LEITUNG 6 POL.	FLEXIBLE CABLE 6P
9503.000		75988-035.58		FLEXIBLE LEITUNG SCR 7 POL.	FLEXIBLE CABLE SCR 7P
9508.000		75988-035.59		FLEXIBLE LEITUNG 3 POL.	FLEXIBLE CABLE 3P
9510.000		75988-036.03		FLEXIBLE LEITUNG 19 POL.	FLEXIBLE CABLE 19P
9514.000		75988-037.38		LEITUNG ABGESCHIRMT 2 POL.	CABLE SCREENED 2P
9519.000		75988-039.53		LEITUNG ABGESCHIRMT 3 POL.	CABLE SCREENED 3P
9521.000		75988-041.12		FLEXIBLE LEITUNG 7 POL.	FLEXIBLE CABLE 7P
9522.000		75988-041.13		FLEXIBLE LEITUNG 8 POL.	FLEXIBLE CABLE 8P
9527.000		75988-039.81		LEITUNG ABGESCHIRMT 5 POL.	CABLE SCREENED 5P
IC 7030		75988-041.11		EPROM QCVG6-1U	EPROM QCVG6-1U
		72010-531.05		BEDIENUNGSANLEITUNG NL/F/E	OPERATING INSTRUCTIONS NL/F/E
		72010-531.10		BEDIENUNGSANLEITUNG S/P	OPERATING INSTRUCTIONS S/P
		72010-531.15		BEDIENUNGSANLEITUNG DK/SF/N	OPERATING INSTRUCTIONS DK/SF/N
		72010-527.35		SERVICE MANUAL D/GB	SERVICE MANUAL D/GB
		72010-527.37		SERVICE MANUAL ERG. D/GB	SERVICE MANUAL SUPP. D/GB
		72010-528.90		SERVICE TRAINING D	SERVICE TRAINING D
		72010-528.91		SERVICE TRAINING GB	SERVICE TRAINING GB
				X = SIEHE GESONDERTE E-LISTE	X = SEE SEPARATE PARTS LIST

Btx *32700#

ÄNDERUNGEN VORBEHALTEN / SUBJECT TO ALTERATION

Ersatzteilliste
Spare Parts List

GRUNDIG

VIDEO

09 / 97

GV 7497 NIC MADRID

SACH-NR. / PART NO.: 77400-837.51
BESTELL-NR. / ORDER NO.: G.MG 3500

POS. NR. POS. NO.	ABB. FIG.	SACHNUMMER PART NUMBER	ANZ. QTY.	BEZEICHNUNG (D)	DESCRIPTION (GB)
0001.000	3	75988-035.27		RAHMEN	FRAME
0001.200	3	27034-208.00	2	MASSEFEDER	EARTH SPRING
0002.000	3	75988-037.35	4	FUSS KPL.	FOOT CPL.
0003.000	3	75988-036.00		BODEN	BOTTOM
0006.000	3	75988-041.38		FRONTPLATTE KPL	FRONT PANEL CPL.
0006.001	3	75988-041.39		CASSETTENFACHKLAPPE	LIFT FLAP
0006.002	3	75988-000.08		SCHENKELFEDER	LEG SPRING
0006.009	3	75988-032.05		SCHRIFTZUG	LABEL
0006.010	3	27061-214.02	2	MAGNET	MAGNET
0006.011	3	27061-151.00	2	DAEMPUNGSLAGERBOCK KPL	DAMPING BEARING BLOCK CPL.
0007.000	3	75988-036.04		DECKEL	LID
0007.100	3	75988-037.36	4	SCHRAUBE 3,5X10	SCREW 3.5X10
0007.200	3	75988-037.64		MASSEFEDER	EARTH SPRING
0008.000	3	75988-041.37		KLAPPE KPL. MIT BEDIENTASTEN	FLAP CPL W. CONTROL KEY
0014.000	3	75988-039.51		PLATINENHALTER	HOLDER PLATINE
0015.000	△	75988-009.52		NETZKABEL	POWER CABLE
0020.000		75988-009.53		HF-VERBINDUNGSKABEL	RF-CONNECTING CABLE
0021.000		75988-010.75		FERNBEDIENUNG RP 500	REMOTE CONTROL RP 500
0021.100		72011-650.00		FERNBEDIENUNG RP 7	REMOTE CONTROL RP 7
0023.000		75988-036.05		EURO-AV KABEL 13 POL.	EURO-AV CABLE 13P
0025.000	△	75988-025.50	X	LAUFWERK KEIN E-TEIL	DRIVE MECHANISM NO SPARE PART
0026.000		75988-037.19	2	DISTANZHALTER DECK	SPACER DECK
0033.000	1	27599-005.24		KOPFRAD 4/2	HEAD WHEEL 4/2
0034.000	1	75988-023.10		SCANNERMOTOR 4/2	SCANNERMOTOR 4/2
0050.000	△	27599-001.95	X	LP-CHASSIS A.PMB31 KEIN E-TEIL	PCB-CHASSIS A.PMB31 NO SPARE PART
0060.000	△	27599-003.20	X	NETZTEILPLATTE PSM2B KEIN E-TEIL / G	POWER SUPPLY BOARD PSM2B NO SPARE PART / G
0070.000	△	27599-002.57	X	BEDIENPLATTE PDCGN1B KEIN E-TEIL / G	CONTROL BOARD PDCGN1B NO SPARE PART / G
0110.000	△	27599-009.03	X	VIDEOTEXT-PLATTE PVT2 KEIN E-TEIL / G	VIDEOTEXT BOARD PVT2 NO SPARE PART / G
0140.000	△	27599-009.51	X	IO/AUDIO PLATTE PIO9 KEIN E-TEIL / G	IO/AUDIO BOARD PIO9 NO SPARE PART / G
0150.000	△	75988-036.15	X	EMPFANGSEINHEIT A.PFE2-BGI KEIN E-TEIL / G	FRONT END PANEL A.PFE2-BGI NO SPARE PART / G
0160.000	3	75988-035.54		TUNER/MODULATOR TP916L	TUNER MODULATOR TP916L
8504.000		75988-035.56		LEITUNG SCR 2 POL.	CABLE SCR 2P
9501.000		75988-037.92		FLEXIBLE LEITUNG 6 POL.	FLEXIBLE CABLE 6P
9503.000		75988-035.58		FLEXIBLE LEITUNG SCR 7 POL.	FLEXIBLE CABLE SCR 7P
9508.000		75988-035.59		FLEXIBLE LEITUNG 3 POL.	FLEXIBLE CABLE 3P
9510.000		75988-036.03		FLEXIBLE LEITUNG 19 POL.	FLEXIBLE CABLE 19P
9514.000		75988-037.38		LEITUNG ABGESCHIRMT 2 POL.	CABLE SCREENED 2P
9518.000		75988-037.39		LEITUNG ABGESCHIRMT 11 POL.	CABLE SCREENED 11P
9527.000		75988-039.81		LEITUNG ABGESCHIRMT 5 POL.	CABLE SCREENED 5P
IC 7030		75988-041.11		EPROM QCVG6-1U	EPROM QCVG6-1U
		72010-531.25		BEDIENUNGSANLEITUNG S/DK/N	OPERATING INSTRUCTIONS S/DK/N
		72010-527.35		SERVICE MANUAL D/GB	SERVICE MANUAL D/GB
		72010-527.37		SERVICE MANUAL ERG. D/GB	SERVICE MANUAL SUPP. D/GB
		72010-528.90		SERVIVE TRAINING D	SERVICE TRAINING D
		72010-528.91		SERVIVE TRAINING GB	SERVICE TRAINING GB
				X = SIEHE GESONDERTE E-LISTE	X = SEE SEPARATE PARTS LIST

Btx *32700#

ÄNDERUNGEN VORBEHALTEN / SUBJECT TO ALTERATION

GRUNDIG

VIDEO

Ersatzteilliste
Spare Parts List

09 / 97

SE 7106 HIFI MADRID

SACH-NR. / PART NO.: 77400-838.51
BESTELL-NR. / ORDER NO.: G.MG 3600

POS. NR. POS. NO.	ABB. FIG.	SACHNUMMER PART NUMBER	ANZ. QTY.	BEZEICHNUNG (D)	DESCRIPTION (GB)
0001.000	3	75988-035.27		RAHMEN	FRAME
0001.200	3	27034-208.00	2	MASSEFEDER	EARTH SPRING
0002.000	3	75988-036.00		BODEN	BOTTOM
0003.000	3	75988-037.35	4	FUSS KPL.	FOOT CPL.
0004.000	3	8114-990-022	3	PLASTITE-SHR 3,5X16	SCREW 3.5X16
0006.000	3	75988-041.19		FRONTPLATTE KPL	FRONT PANEL CPL
0006.001	3	75988-041.20		CASSETTENFACHKLAPPE	LIFT FLAP ASSY
0006.002	3	75988-000.08		SCHENKELFEDER	LEG SPRING
0006.009	3	75988-032.05		SCHRIFTZUG	LABEL
0006.010	3	27061-214.02	2	MAGNET	MAGNET
0006.011	3	27061-151.00	2	DAEMPUNGSLAGERBOCK KPL	DAMPING BEARING BLOCK CPL
0007.000	3	75988-036.04		DECKEL	LID
0007.100	3	75988-037.36	4	SCHRAUBE 3,5X10	SCREW 3.5X10
0007.200	3	75988-037.64		MASSEFEDER	EARTH SPRING
0008.000	3	75988-041.21		KLAPPE KPL. MIT BEDIENTASTEN	FLAP CPL W. CONTROL KEY
0013.000	3	75988-018.18	2	SCHRAUBE, AUDIO SUPPORT	SCREW, AUDIO SUPPORT
0014.000	3	75988-039.51		PLATINENHALTER	HOLDER PLATINE
0015.000	△	75988-009.52		NETZKABEL	POWER CABLE
0020.000		75988-009.53		HF-VERBINDUNGSKABEL	RF-CONNECTING CABLE
0021.000		75988-010.75		FERNBEDIENUNG RP 500	REMOTE CONTROL RP 500
0021.100		72011-650.00		FERNBEDIENUNG RP 7	REMOTE CONTROL RP 7
0023.000		75988-036.05		EURO-AV KABEL 13 POL.	EURO-AV CABLE 13P
0025.000	△	75988-025.50	X	LAUFWERK KEIN E-TEIL	DRIVE MECHANISM NO SPARE PART
0026.000		75988-037.19	2	DISTANZHALTER DECK	SPACER DECK
0033.000	1	27599-005.24		KOPFRAD 4/2	HEAD WHEEL 4/2
0034.000	1	75988-023.10		SCANNERMOTOR 4/2	SCANNERMOTOR 4/2
0050.000	△	27599-001.93	X	LP-CHASSIS A.PMB8 KEIN E-TEIL	PCB-CHASSIS A.PMB8 NO SPARE PART
0060.000	△	27599-003.20	X	NETZTEILPLATTE PSM2B KEIN E-TEIL / G	POWER SUPPLY BOARD PSM2B NO SPARE PART / G
0070.000	△	27599-002.57	X	BEDIENPLATTE PDCGN1B KEIN E-TEIL / G	CONTROL BOARD PDCGN1B NO SPARE PART / G
0110.000	△	27599-009.03	X	VIDEOTEXT-PLATTE PVT2 KEIN E-TEIL / G	VIDEOTEXT BOARD PVT2 NO SPARE PART / G
0140.000	△	27599-009.51	X	IO/AUDIO PLATTE PIO9 KEIN E-TEIL / G	IO/AUDIO BOARD PIO9 NO SPARE PART / G
0150.000	△	75988-036.09	X	EMPFANGSEINHEIT A.PFE-BGI KEIN E-TEIL / G	FRONT END PANEL A.PFE-BGI NO SPARE PART / G
0160.000		75988-035.54		TUNER/MODULATOR PAL-BG	TUNER MODULATOR PAL-BG
8504.000		75988-035.56		LEITUNG SCR 2 POL.	CABLE SCR 2P
9501.000		75988-037.92		FLEXIBLE LEITUNG 6 POL.	FLEXIBLE CABLE 6P
9503.000		75988-035.58		FLEXIBLE LEITUNG SCR 7 P.	FLEXIBLE CABLE SCR 7P
9508.000		75988-035.59		FLEXIBLE LEITUNG 3 POL.	FLEXIBLE CABLE 3P
9510.000		75988-036.03		FLEXIBLE LEITUNG 19 POL.	FLEXIBLE CABLE 19P
9514.000		75988-037.38		LEITUNG ABGESCHIRMT 2 POL.	CABLE SCREENED 2P
9518.000		75988-037.39		LEITUNG ABGESCHIRMT 11 POL.	CABLE SCREENED 11P
9527.000		75988-039.81		LEITUNG ABGESCHIRMT 5 POL.	CABLE SCREENED 5P
IC 7030		75988-041.11		EPROM QCVG6-1U	EPROM QCVG6-1U
		72010-531.20		BEDIENUNGSANLEITUNG D/II/NL/F	OPERATING INSTRUCTIONS D/II/NL/F
		72010-527.35		SERVICE MANUAL D/GB	SERVICE MANUAL D/GB
		72010-527.37		SERVICE MANUAL ERG. D/GB	SERVICE MANUAL SUPP. D/GB
		72010-528.90		SERVIVE TRAINING D	SERVICE TRAINING D
		72010-528.91		SERVIVE TRAINING GB	SERVICE TRAINING GB
				X = SIEHE GESONDERTE E-LISTE	X = SEE SEPARATE PARTS LIST

Btx *32700#

ÄNDERUNGEN VORBEHALTEN / SUBJECT TO ALTERATION

Ersatzteilliste
Spare Parts List

VIDEO

09 / 97

ALLE NICHT AUFGEFÜHRTEN E-TEILE
SIEHE E-LISTE CHASSISPL. 27599-001.92ALL PARTS NOT LISTED REFER TO
PARTS-LIST FAMILY BOARD 27599-001.92CHASSISPLATTE A.PMB8
FAMILY BOARD A.PMB8

SACH-NR. / PART NO.: 27599-001.93

POS. NR. POS. NO.	ABB. FIG.	SACHNUMMER PART NUMBER	ANZ. QTY.	BEZEICHNUNG (D)	DESCRIPTION (GB)
----------------------	--------------	---------------------------	--------------	--------------------	---------------------

1528.000		75988-035.25		STECKVERBINDER 12 POL	CONNECTOR 12P
----------	--	--------------	--	-----------------------	---------------

POS. NR. POS. NO.	SACHNUMMER PART NUMBER	BEZEICHNUNG DESCRIPTION	POS. NR. POS. NO.	SACHNUMMER PART NUMBER	BEZEICHNUNG DESCRIPTION
----------------------	---------------------------	----------------------------	----------------------	---------------------------	----------------------------

IC 7032	75988-035.26	SMD-IC UM62256DM-70LL (UNM)
IC 7085	75988-041.17	IC TMP 91C642AF PTDU8-8U

R 3503	75988-037.41	TRIMMER LIN 100K 30%
R 3508	75988-037.41	TRIMMER LIN 100K 30%

POS. NR. POS. NO.	SACHNUMMER PART NUMBER	BEZEICHNUNG DESCRIPTION
----------------------	---------------------------	----------------------------

D 6032	75988-027.76	DIODE BYV10-20
D 6036	8309-200-021	DIODE BAV21 ITT/ TFK
D 6042	8309-204-003	DIODE BY 268 TFK
D 6046	8309-215-006	DIODE 1 N 4001
D 6048	8309-215-006	DIODE 1 N 4001
D 6050	75988-010.69	GLEICHRICHTER DF 08 M/ RECTIFIER
D 6076	75988-027.73	DIODE BYT 52 M
D 6080	75988-324.25	DIODE BYW 98-200 RL
D 6081	75988-027.73	DIODE BYT 52 M
D 6082	75988-027.73	DIODE BYT 52 M
D 6084	75988-039.17	DIODE R. OF 4344 A (ELCO)
D 6088	75988-324.25	DIODE BYW 98-200 RL
D 6092	75988-324.25	DIODE BYW 98-200 RL
D 6098	75988-031.82	DIODE REC MBR 360 RL

Ersatzteilliste
Spare Parts List

VIDEO

09 / 97

NETZTEILPLATTE PSM2B
POWER SUPPLY BOARD PSM2B

SACH-NR. / PART NO.: 27599-003.20

POS. NR. POS. NO.	ABB. FIG.	SACHNUMMER PART NUMBER	ANZ. QTY.	BEZEICHNUNG (D)	DESCRIPTION (GB)
----------------------	--------------	---------------------------	--------------	--------------------	---------------------

0008.000	△	75988-001.92		NETZBUCHSE	MAINS SOCKET
0010.000		75988-010.55		SICHERUNGSHALTER	FUSE HOLDER
0011.000		75988-010.55		SICHERUNGSHALTER	FUSE HOLDER

POS. NR. POS. NO.	SACHNUMMER PART NUMBER	BEZEICHNUNG DESCRIPTION	POS. NR. POS. NO.	SACHNUMMER PART NUMBER	BEZEICHNUNG DESCRIPTION
----------------------	---------------------------	----------------------------	----------------------	---------------------------	----------------------------

C 2050	△	8511-793-014	MP 3 0.068UF 20% 250VW	OK 7070	△	75988-010.62	OPTOKOPPLER SOC 1012 T
C 2052	△	8511-793-014	MP 3 0.068UF 20% 250VW	R 3058	△	75988-001.77	MSW 0411 3,9 MOHM 5% AX
C 2054	△	75988-035.69	KONDENSATOR 470P 250V 20%	R 3059	△	75988-001.77	MSW 0411 3,9 MOHM 5% AX
C 2056	△	75988-035.69	KONDENSATOR 470P 250V 20%	R 3068	△	75988-041.22	SICHERUNGSWIDERST. NER25
C 2059	△	75988-035.69	KONDENSATOR 470P 250V 20%/ CAPACITOR	R 3078		75988-041.23	TRIMMER 470 OHM LIN
C 2084	△	75988-005.91	ELKO 25V 680UF	R 3080	△	75988-027.67	MSW NB 0207 47 OHM 5%
C 2098	△	75988-005.91	ELKO 25V 680UF	SI 1010	△	75988-010.51	SICHERUNG T 1A25 250V/FUSE
C 2099	△	75988-005.91	ELKO 25V 680UF	T 7040		75988-027.80	TRANS. STP3NA60
D 6032		75988-027.76	DIODE BYV10-20	T 7050		8303-207-547	TRANS.BC 547 C
D 6036		8309-200-021	DIODE BAV21 ITT/ TFK	T 7056		8303-207-547	TRANS.BC 547 C
D 6042		8309-204-003	DIODE BY 268 TFK	T 7058		75988-010.40	TRANS.BC 337-40
D 6046		8309-215-006	DIODE 1 N 4001	T 7060		8303-274-327	TRANS.BC 327-40
D 6048		8309-215-006	DIODE 1 N 4001	T 7084		8303-207-547	TRANS.BC 547 C
D 6050		75988-010.69	GLEICHRICHTER DF 08 M/ RECTIFIER	T 7090		75988-021.27	TRANS. FET POW STD17N06
D 6076		75988-027.73	DIODE BYT 52 M	T 7096		8303-207-547	TRANS.BC 547 C
D 6080		75988-324.25	DIODE BYW 98-200 RL	TR 5050	△	75988-039.18	TRAFO D13205-14/ TRANSFORMER
D 6081		75988-027.73	DIODE BYT 52 M				
D 6082		75988-027.73	DIODE BYT 52 M				
D 6084		75988-039.17	DIODE R. OF 4344 A (ELCO)				
D 6088		75988-324.25	DIODE BYW 98-200 RL				
D 6092		75988-324.25	DIODE BYW 98-200 RL				
D 6098		75988-031.82	DIODE REC MBR 360 RL				
F 5010	△	75988-035.32	FILTER CHOKE				
IC 7020		75988-027.79	IC MC 44603 F				
IC 7074		75988-019.93	IC TL 431CS-AP				
IC 7085		75988-019.93	IC TL 431CS-AP				
IC 7088		8305-205-765	IC 7812 3% SAM				
L 3061		8104-982-014	DAEMPFUNGSPELLE 4330 030/ DAMPING BEAD				
L 5080		75988-010.52	SPULE 22UH/COIL				
L 5088		75988-010.52	SPULE 22UH/COIL				
L 5090		75988-010.52	SPULE 22UH/COIL				
L 5098		75988-010.52	SPULE 22UH/COIL				

Es gelten die Vorschriften und Sicherheitshinweise gemäß dem Service Manual "Sicherheit", Sach-Nummer 72010-800.00, sowie zusätzlich die eventuell abweichenden, landesspezifischen Vorschriften!



The regulations and safety instructions shall be valid as provided by the "Safety" Service Manual, part number 72010-800.00, as well as the respective national deviations.

ÄNDERUNGEN VORBEHALTEN / SUBJECT TO ALTERATION

Btx *32700#

Es gelten die Vorschriften und Sicherheitshinweise gemäß dem Service Manual "Sicherheit", Sach-Nummer 72010-800.00, sowie zusätzlich die eventuell abweichenden, landesspezifischen Vorschriften!



The regulations and safety instructions shall be valid as provided by the "Safety" Service Manual, part number 72010-800.00, as well as the respective national deviations.

ÄNDERUNGEN VORBEHALTEN / SUBJECT TO ALTERATION

Btx *32700#

GRUNDIG

VIDEO

Ersatzteilliste
Spare Parts List**09 / 97**ALLE NICHT AUFGEFÜHRTEN E-TEILE
SIEHE E-LISTE BEDIENPL. 27599-002.58ALL PARTS NOT LISTED REFER TO
PARTS-LIST CONTROL BOARD 27599-002.58**BEDIENPLATTE GDCG1
CONTROL BOARD GDCG1**

SACH-NR. / PART NO.: 29599-002.75

POS. NR. POS. NO.	ABB. FIG.	SACHNUMMER PART NUMBER	ANZ. QTY.	BEZEICHNUNG (D)	DESCRIPTION (GB)
0004.000		75988-009.27		IR-HALTER	IR HOLDER
0006.000		75988-037.81		HALTER, DISPLAY	HOLDER, DISPLAY
1510.000		75988-027.24		STECKERLEISTE 19P	MULTIPOINT CONNECTOR 19P
1515.000		75988-041.16		VERBINDER 8POL. HOR HLEM	CONNECTOR 8P HOR HLEM
1516.000		75988-000.96		STECKERLEISTE 7P	MULTIPOINT CONNECTOR 7P
7202.000		75988-035.34		DISPLAY BJ-440-GK	DISPLAY BJ-440-GK

POS. NR. POS. NO.	SACHNUMMER PART NUMBER	BEZEICHNUNG DESCRIPTION	POS. NR. POS. NO.	SACHNUMMER PART NUMBER	BEZEICHNUNG DESCRIPTION
C 2060	8699-999-356	TR.15 7,5/50PF VCT 56			
D 6000	8309-198-085	DIODE BAT85 PHI			
D 6003	8309-198-085	DIODE BAT85 PHI			
D 6025	8309-214-218	DIODE TD129 UNI/1N4148/BA			
D 6052	8309-214-218	DIODE TD129 UNI/1N4148/BA			
D 6070	75988-017.39	DIODE BZX 79 C 10			
D 6094	8309-214-218	DIODE TD129 UNI/1N4148/BA			
D 6095	8309-214-218	DIODE TD129 UNI/1N4148/BA			
D 6096	8309-214-218	DIODE TD129 UNI/1N4148/BA			
D 6097	8309-214-218	DIODE TD129 UNI/1N4148/BA			
IC 7201	75988-039.10	IC TMP 87CH70AF PDP11-2U			
IC 7203	75988-041.51	IR-EMPFÄNGER TSOP1730/ IR RECEIVER			
L 5000	75988-019.53	DR 0207 68 UH 5% AX			
L 5001	75988-324.16	SPULE 22MU PM10/COIL			
R 3074	△ 75988-035.70	SICH.WIDERSTAND 18 OHM 5%/ FUSE RESISTOR			
S 1203	75988-041.15	TIP-TASTE			
S 1204	75988-041.15	TIP-TASTE			
S 1205	75988-041.15	TIP-TASTE/ TOUCH DOWN BUTTON			
T 7010	8301-004-857	SMD-TRANS.BC 857 B			
T 7055	8301-004-847	SMD-TRANS.BC 847 B			
T 7085	8301-004-847	SMD-TRANS.BC 847 B			
T 7087	8301-004-847	SMD-TRANS.BC 847 B			
T 7089	8301-004-847	SMD-TRANS.BC 847 B			
T 7181	8301-004-847	SMD-TRANS.BC 847 B			
T 7182	8301-004-847	SMD-TRANS.BC 847 B			
T 7183	8301-004-847	SMD-TRANS.BC 847 B			
T 7184	8301-004-847	SMD-TRANS.BC 847 B			

Es gelten die Vorschriften und Sicherheitshinweise gemäß dem Service Manual "Sicherheit", Sach-Nummer 72010-800.00, sowie zusätzlich die eventuell abweichenden, landesspezifischen Vorschriften!



The regulations and safety instructions shall be valid as provided by the "Safety" Service Manual, part number 72010-800.00, as well as the respective national deviations.

Btx *32700#

ÄNDERUNGEN VORBEHALTEN / SUBJECT TO ALTERATION

GRUNDIG

VIDEO

Ersatzteilliste
Spare Parts List**09 / 97****BUCHSENPLATTE QBG1
SOCKET BOARD QBG1**

SACH-NR. / PART NO.: 75988-041.10

POS. NR. POS. NO.	ABB. FIG.	SACHNUMMER PART NUMBER	ANZ. QTY.	BEZEICHNUNG (D)	DESCRIPTION (GB)
0005.000		75988-041.14		LEITUNG KPL.	CABLE CPL.
1514.000		39604-122.01		DRAHTKLEMM-STECKVBDG.2-POL.	WIRE CLAMP CONNECTOR 2 P
1519.000		75988-039.61		STECKVERBINDER 3 POL.	CONNECTOR 3 P
1901.000		75988-038.68		CINCH BUCHSE GELB	CINCH SOCKET YELLOW
1902.000		75988-038.70		CINCH BUCHSE WEISS	CINCH SOCKET WHITE
1903.000		75988-038.69		CINCH BUCHSE ROT	CINCH SOCKET RED

POS. NR. POS. NO.	SACHNUMMER PART NUMBER	BEZEICHNUNG DESCRIPTION	POS. NR. POS. NO.	SACHNUMMER PART NUMBER	BEZEICHNUNG DESCRIPTION
D 6120	8309-720-068	Z DIODE 6,8 C 0,5W			
D 6123	8309-720-068	Z DIODE 6,8 C 0,5W			
D 6150	75954-020.90	SMD-DIODE BAS 216			
D 6151	75954-020.90	SMD-DIODE BAS 216			
D 6152	75954-020.90	SMD-DIODE BAS 216			
D 6153	75954-020.90	SMD-DIODE BAS 216			

Es gelten die Vorschriften und Sicherheitshinweise gemäß dem Service Manual "Sicherheit", Sach-Nummer 72010-800.00, sowie zusätzlich die eventuell abweichenden, landesspezifischen Vorschriften!



The regulations and safety instructions shall be valid as provided by the "Safety" Service Manual, part number 72010-800.00, as well as the respective national deviations.

Btx *32700#

ÄNDERUNGEN VORBEHALTEN / SUBJECT TO ALTERATION

GRUNDIG

Marketing und Vertrieb Europa GmbH
Kundendienst
Deutschland



GRUNDIG

Marketing und Vertrieb Europa GmbH
Kundendienst
Europa

